

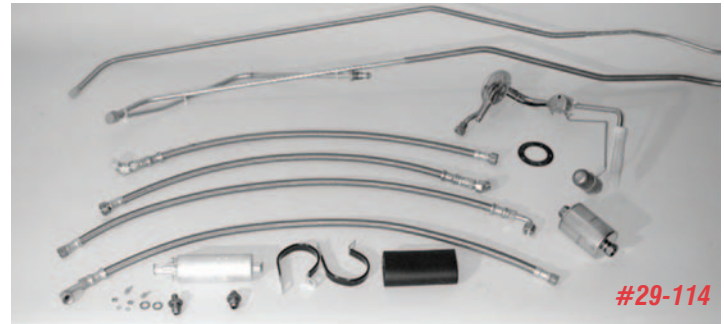
## 1955-57 SMALL BLOCK LS1 INSTALLATION



### Randy Irwin - Technical Writer

Randy has been involved in the Chevy parts business for over 25 years. He is a wizard at creating, making and modifying custom parts for Chevys.

In 1955, the all-new overhead valve 265 ci small block Chevy was all the rage and really put Chevrolet on the map. The small block Chevy soon replaced the flathead Ford as "the" hot-rodders engine. Ever since then, car-guys have been pulling the stock engines out of their cars and installing larger, more powerful engines. Next to the 1932 Henry, the Tri-Five Chevy's have become the most modified car on the planet. In the '60's and '70's it was a hot 327 or 350 small block. In the 1980's it was time to shoe-horn in a big block Chevy. Now with a few more years of technology behind us, it's time to install an engine that requires no maintenance, is super lightweight, puts out unbelievable horsepower and torque yet gives you a car you can just jump in, hit the key and go. No pumping the gas pedal, no adjusting the choke, no setting idle air screws, no setting the points (what are they?). It's now time for a reliable engine with electronic fuel injection and a transmission that you just stick in gear and go. In the last few years, the LS1 engines used in Chevy F-body cars (Camaro and Firebird) and Corvettes have become readily available at all salvage yards. It's time to get our hands on one of these engines and drop it into a Classic. The LS1 engine is part of the GM LS series which includes LS1, LS2 and LS6 small blocks. This installation procedure will work for all LS1, 2 and 6 series engines. In this article, when we refer to the LS1, we are referring to the LS2 and LS6 as well.



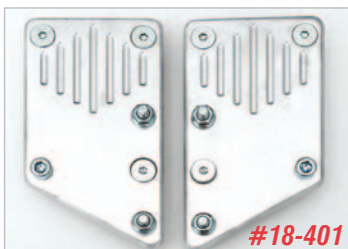
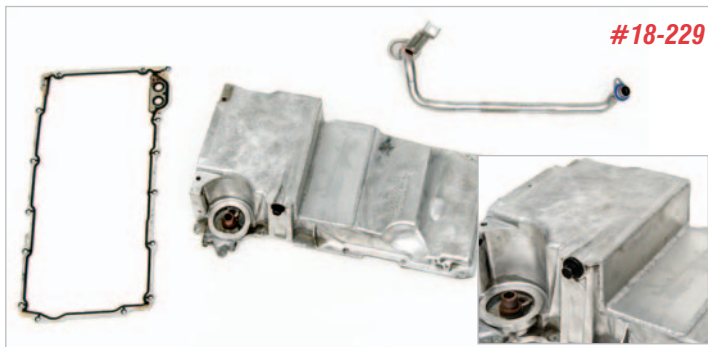
### Parts List:

- 18-229 LS1 Cast Aluminum Oil Pan (No Core)
- 18-228 LS1 Cast Aluminum Oil Pan "Exchange" (Send In Your Core)
- 18-374 LS1 Sheet Metal Oil Pan
- 18-375 LS1 Sheet Aluminum Oil Pan
- 24-137 Uncoated LS1 Headers ▲
- 24-137C Ceramic Coated LS1 Headers ▲
- 18-400 LS1 Engine Adapter Plates (Polished)
- 18-401 LS1 Engine Adapter Plates (Unpolished)
- 18-02 Small Block Side Engine Mount Kit
- 19-153 Non-Convertible Transmission Crossmember
- 34-300 LS1 Bellhousing Bolts
- 08-278 LS1 Manual Transmission Flywheel Bolts
- 08-279 LS1 Automatic Flexplate Bolts
- 08-104 LS1 Manual Transmission Aluminum Flywheel
- 19-179 LS1 Automatic Flexplate
- 08-105 Centerforce II Clutch & Pressure Plate
- 08-23 Aluminum Bellhousing
- 08-400 Tremec 5-Speed Transmission
- 19-26 Manual Transmission Rear Mount
- 29-114 Non-Wagon LS1, LS2 & LS6 Fuel Line/Pump Kit \* ▲
- 29-115 Wagon LS1, LS2 & LS6 Fuel Line/Pump Kit \* ▲

\* You must send your fuel feed and return push-on fittings at the injector to us for installation on the line kit.

▲ Oversized item. Additional shipping and handling fee will be applied.

To order parts call 1-800-456-1957 or visit ClassicChevy.com

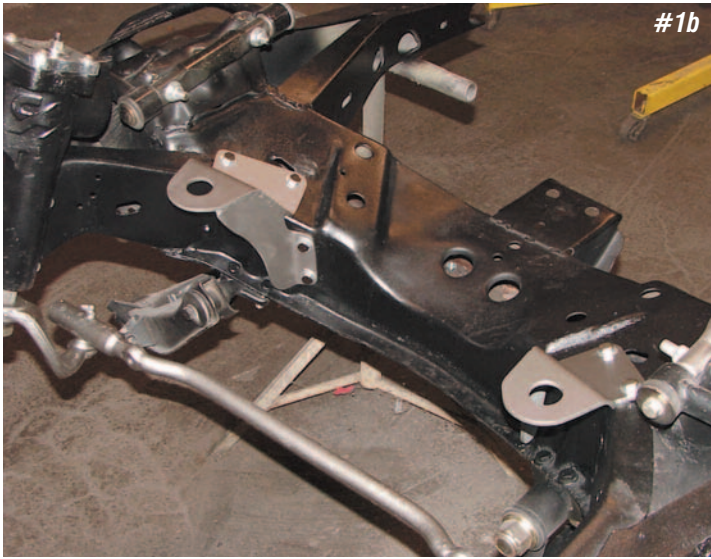
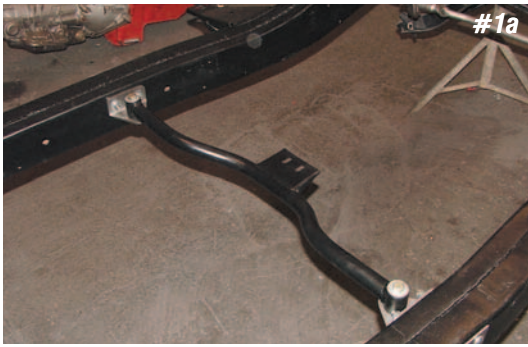


### Tools Needed:

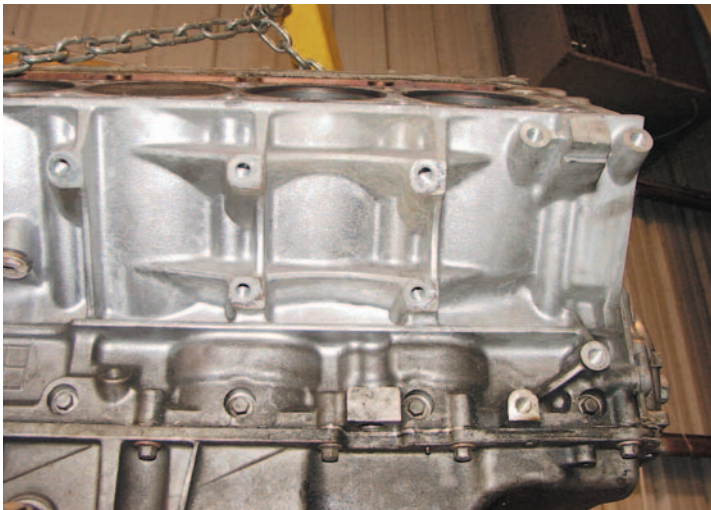
- Electric Drill w/ 3/8" Drill Bit
- 10 Millimeter Wrench
- 9/16" Wrench
- 7 Millimeter Allen Wrench
- 14 Millimeter Wrench

### Time Frame:

6 hours



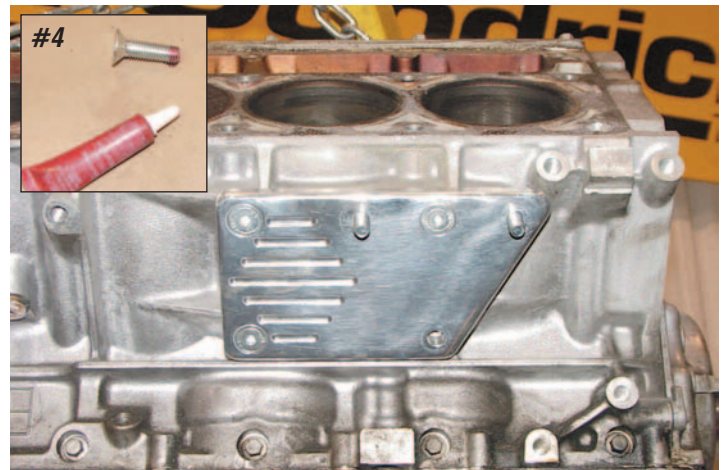
**Photos #1a & #1b:** Our project frame has been upgraded with the small block side mounts **P/N 18-02** and the tubular transmission crossmember **P/N 19-153**. These upgrades are all bolt-in and will allow the installation of an early model small block in the stock V8 location.



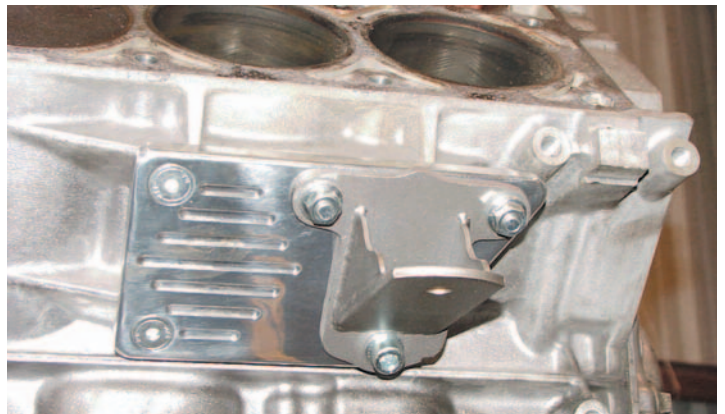
**Photo #2:** Prior to 1997, the non-LS engines had three bosses on the side of the engine block for the motor mounts. The 1997 and newer LS1 engines have four bosses on the side of the block for the motor mounts that will not bolt directly to the early style side mounts.



**Photo #3:** Our aluminum installation plate kit, **P/N 18-400** (polished) or **P/N 18-401** (unpolished) will bolt to the side of the LS1 engine using the stock four bosses and allow the early side engine mount kit **P/N 18-02** to be used.

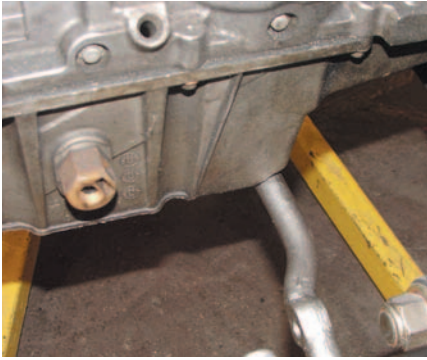


**Photo #4:** The adapter plates are held to the side of the engine block with three 8 millimeter countersunk Allen head bolts. The lower forward hole is not used. When installing the bolts use a small amount of thread locker on the threads.

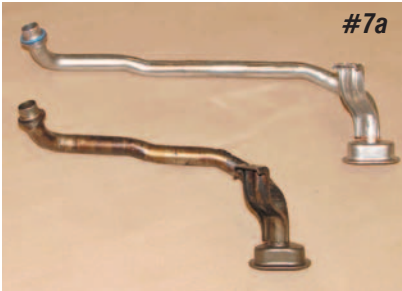


**Photo #5:** The early style (pre-1997) side engine mount **P/N 18-02** is held to the adapter plate with two lock nuts at the top of the plate and one Allen head bolt at the bottom. The lower Allen head bolt will pass through the adapter plate and screw into the lower forward hole on the side of the engine block.

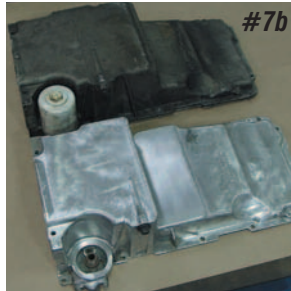
# YOU CAN DO IT EASY UPGRADES



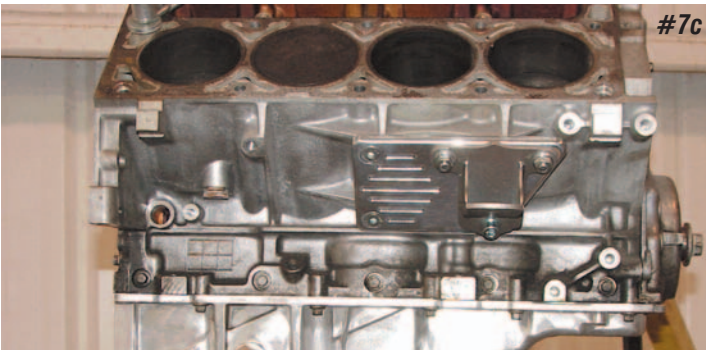
**Photo #6:** The rear sump on a stock LS1 oil pan is far longer than the original small block pan. With the length of the sump, the steering drag link or rack and pinion mounting support will not clear, so a custom oil pan must be used.



#7a

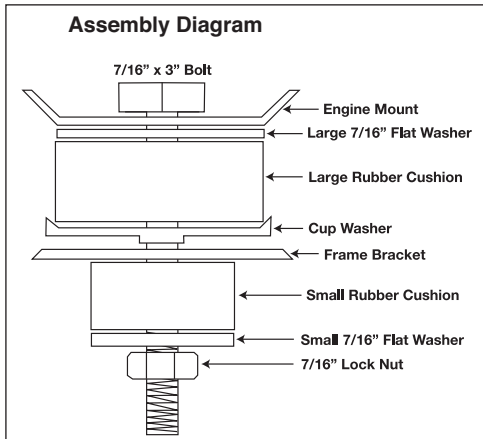


#7b

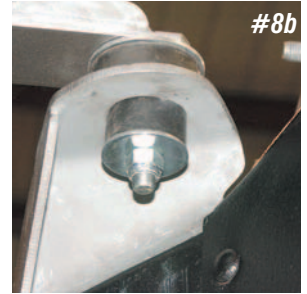


#7c

**Photos #7a, #7b & #7c:** We carry a modified GM cast aluminum oil pan P/N 18-228 that is designed to clear the steering component. This pan includes the oil pump pick up and pan gasket. For a more custom look, fully fabricated sheet metal oil pans are also available P/N 18-374 in steel or P/N 18-375 in aluminum. All three pans will work with the stock drag link or the CCI rack and pinion unit.



#8a



#8b

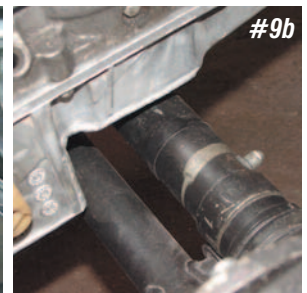


#8c

**Photos #8a, #8b & #8c:** With the new oil pan installed, the engine can be set down into the frame. The side engine mounts are held to the frame brackets with 7/16" x 3" bolts and lock nuts on each side. There is a large rubber grommet between the engine bracket and frame bracket and a smaller one on the bottom of the frame bracket. (See Assembly Diagram below left.)



#9a

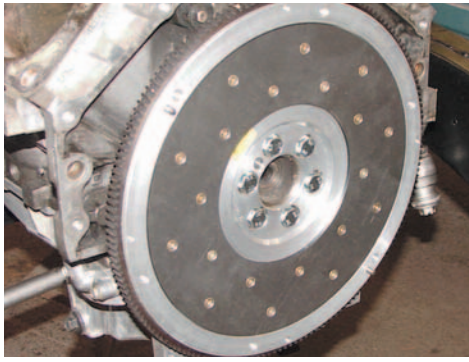


#9b

**Photos #9a & #9b:** You can see how much steering linkage clearance there is with the modified oil pan. The left photo shows the stock drag link and the right photo shows the rack and pinion.

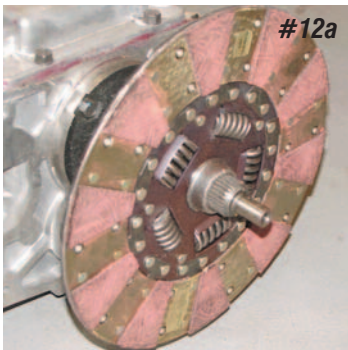


**Photo #10:** The back of an LS1 engine block has the same bolt pattern as an early Chevy V8 engine with one exception, there are only five bellhousing bolts instead of the normal six bolts.



**Photos #11:** The hub on the crankshaft for the flywheel or flexplate is specific for the LS1 engines. P/N 08-278 is the bolt kit for a standard transmission flywheel and P/N

08-279 is the bolt kit for the automatic flexplate Torque the bolts to 45 ft/lbs. We installed the P/N 08-104 two-piece aluminum flywheel. This flywheel weighs just 12 pounds for quicker throttle response and an improved friction surface for a much better grip on the clutch disc.



#12a



#12b

**Photos #12a & #12b:** We are installing the Centerforce II 11" clutch and pressure plate kit P/N 08-105. The clutch disc has 21 splines to fit the Muncie M21 or the Tremec 5-speed transmissions.



**Photos #13:** Along with the Centerforce II clutch kit, we are going to install an aluminum bellhousing, P/N 08-23 which is a reproduction of the late 60's early 70's big block bellhousing. The bellhousing has the standard bolt pattern that will accept a Saginaw, Muncie, Tremec or Richmond transmission and will bolt to small or big blocks and provides room for an 11" clutch.

**Photos #14:** The Tremec 5-speed transmission P/N 08-400 is a perfect compliment for the powerful LS1 engine. The Tremec transmission bolts to the P/N 08-23



bellhousing with four 1/2" x 1 1/2" course thread bolts and lock washers. The tubular transmission crossmember P/N 19-153 and transmission mount P/N 19-26 will support the tail shaft properly. Refer to January 2006 *Classic Chevy World* for the complete Tremec installation.



#15a



**Photos #15a & #15b:** Headers for the LS1 P/N 24-137 are available painted black or silver ceramic coated These headers will work with a stock steering box, 605, 670 power steering box or a CCI rack and pinion unit. The headers will not work with manual clutch linkage, so if a manual transmission is going to be used, a hydraulic clutch system must be installed. Refer to October 2006 *Classic Chevy* for complete instructions.



**Photos #16:** The driver's side header has an O2 sensor bung welded into the collector to be connected to the computer for the LS1.



#17a



**Photos #17a & #17b:** Using the CCI side mount kit P/N 18-02 and adapter plates P/N18-400 to locate the LS1 engine there will be plenty of room between the back of the cylinder heads and the firewall. Installation of an automatic like a 700R4 is similar.

With everything mocked up we can't wait for our real engine to come back from the machine shop and so we can drop it into the frame. With the power, torque and smoothness of an LS engine and the durability and overdrive capability of a Tremec 5-speed the car will drive like a dream! Good Luck! 